



PAK TURK

MX2

MANUAL

READ THE INSTRUCTIONS AND
WARNINGS IN THIS MANUAL
CAREFULLY BEFORE USING THIS
FIREARM

QUALITY CONTROL - WARRANTY CARD

Serial No. of weapon _____ Model _____

Manufacturer _____

Caliber _____ Year of manufacture _____ Barrel Length _____

Number of Cartridges and grams of cartridges tested _____

Chamber details _____

PURCHASER _____

Address _____

Purchase date _____

Signature _____

PLEASE SIGN AND RETURN THIS CARD TO VALIDATE WARRANTY



INTERNATIONAL ARMS & SECURITY

MX2
SERIES
INSTRUCTION MANUAL

As a rifle owner, we will state the following safe rifle usage rules. You must comply exactly!

- Keep your rifle out of reach of children. - Keep your rifle and cartridge in separate places. - Do not store the rifle fully loaded. - After your shot is finished, unload your rifle. Make sure your rifle is unloaded and safe when climbing a tree, jumping over a fence or walking on a slippery surface. -Do not load your rifle before you reach the place where you will shoot. NEVER keep your finger on the trigger before you see the target and decide to fire. - Never shoot at water, rocks or hard surfaces. Regardless of whether your rifle is loaded or unloaded, always make sure that the muzzle of your rifle is pointed in a safe direction. - When giving your rifle to anyone, make sure that the mechanism is fully open and your rifle is safe and without a cartridge. -Always use goggles and headphones while shooting. -After using your rifle, be sure to disassemble the barrel, the choke on the barrel, the gas chamber, the piston, the mechanism, and replace them after cleaning and lubricating them. -When shooting with your rifle, make sure that the fore-end fixing nut, the barrel fixing nut and the gas chamber fixing nut are tightened. (Don't forget to tighten the connection nuts after disassembling your rifle for cleaning or any other reason)

Otherwise, your rifle will leak gas and the barrel will not be stable, so the operating efficiency will decrease.

Safety rules are very important for the protection of you and your loved ones. Ignoring the points specified in the instructions for use can cause very serious injuries.

Keep your operating instructions as long as you use your rifle. If your rifle changes hands, also hand over your operating instructions. For any lost or missing user manual, please request a free copy from your factory or you can access the information you want from www.blackacestactical.com After cleaning, disassembling or assembling your rifle, please check the functional suitability of the rifle once again before using the cartridge. Any modification made outside of our factory and improper assembly of parts to your rifle can cause very dangerous errors and as a result, serious damage to the user and the people around! Correct assembly and operability of the rifle after any disassembly and reassembly is entirely the responsibility of the user. NEVER enter any cartridge filling and use process without fully reading and understanding the information in this user manual. Before using your rifle, definitely learn the working principles of your rifle, these operations include **"TAKING SAFE POSITION"**, other safety features, opening and closing the mechanism safely, loading and unloading in a safe manner.

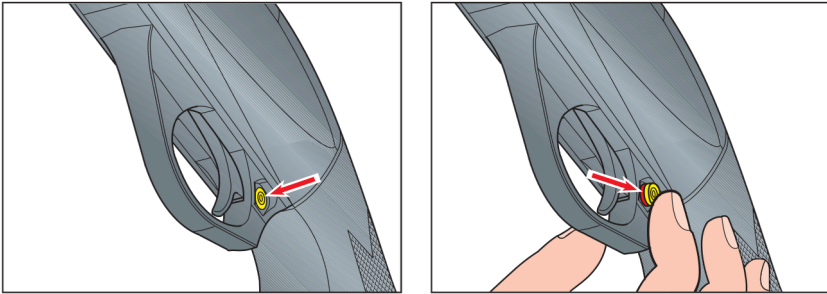

White dot, safety is on gun is ready to fire
Red dot safety is off

IMPORTANT WARNING • NEVER RELY ON MECHANICAL SAFETY SYSTEMS. Like all other mechanical parts, the safety system can also break, malfunction, wear out, deteriorate, fail to function due to faulty assembly or lack of maintenance. Being dependent on the safety system and relying on it completely does not fit the right rifle usage conditions. • NO SAFETY SYSTEM can prevent the accidental discharge of children or those who do not know how to use the rifle, while playing with the rifle, and the consequences they may cause. • Assume each rifle as "NO MECHANICAL SAFETY SYSTEM" and take your precautions according to this criterion. **MATTERS TO BE CONSIDERED WHEN SHOOTING** Keep your fingers or other objects away from the action area of the bolt and the charging handle while firing, as the mechanism moves back and forth very quickly when firing. Keep the safety on and keep your fingers outside the trigger guard until you are fully ready to fire and fully aim at your target. The mechanism remains open when the last cartridge in the magazine is fired. But never rely on it. Always look inside the magazine to make sure there are no cartridges left. Like all other semi-automatic rifles, the Black Aces (omen model) semi-automatic rifle automatically drives the next cartridge from the magazine into the chamber every time you shoot. Since no mechanical force other than pulling the trigger is required for this process, the rifle is ready for the next shot after each shot.

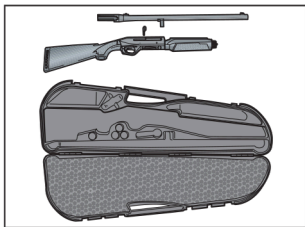

a) stock-receiver-bolt-fore-end unit
b) barrel-breech unit.

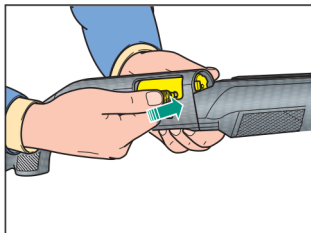

Insert completely the bolt handle into the breech bolt unit.

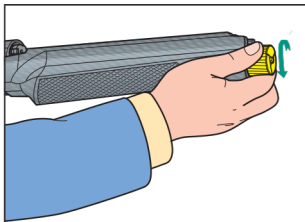

Slide the fore-end of the magazine tube

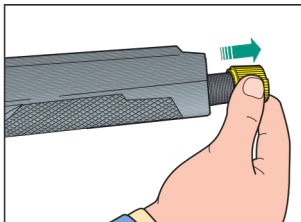

Remove the red plastic bolt clip from its seat in the receiver.

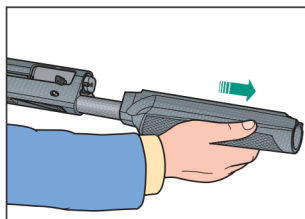

Take the stock-receiver-bolt unit with a hand; with the other hand, using the cocking lever, bring the bolt into open position.

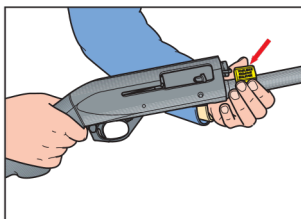

Install the fore end on the barrel-breech unit. The fore end must first be slid over the barrel guide ring and the snapped onto the barrel.

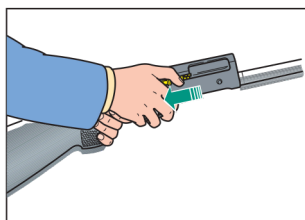

Take the stock-receiver-bolt unit with one hand and with the other take hold of the previously formed barrel-breech-fore-end unit. Fit the breech extension onto the receiver by sliding the fore-end along the magazine tube.

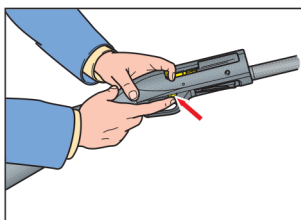

As the barrel extension nears the bolt group, carefully align the barrel extension (sight) with the top of the protruding bolt head.

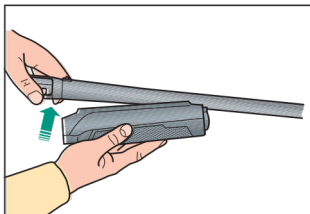

With the barrel extension resting on the bolt head, and the bolt head fitting into the recess formed into the barrel extension, slip the barrel into receiver. A metallic click will indicate the barrel is correctly seated.

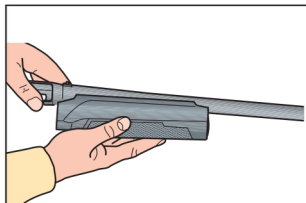

Screw the fore-end gas cap on the tubular magazine and fastening the whole barrel-breech-fore-end unit tightly

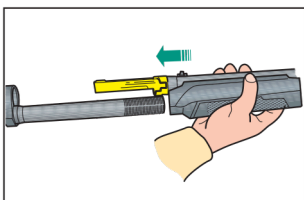

Insert the barrel-magazine-tube retaining ring over the magazine tube and install in the associated seat. Secure the ring in seat by tightening the associated screw.

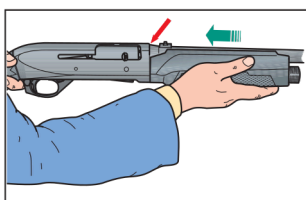

Insert the barrel into the receiver and pull the forend backward tightly as shown in the photo.

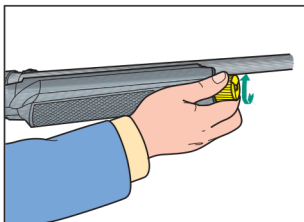

Make sure that barrel is fitted well onto receiver, and tightly put the forend cap as shown in the photo.

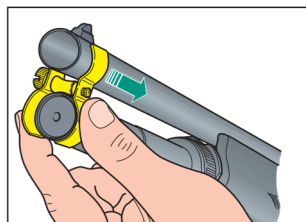

Insert barrel and forend clamp and take it in the middle position.

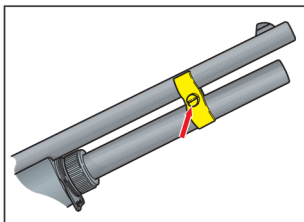

Tighten the clamp screw firmly.

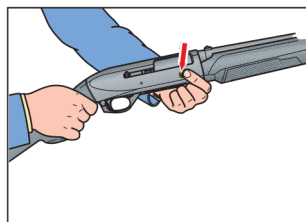

Push bolt release button in order to make sure barrel assembly is fitted properly.

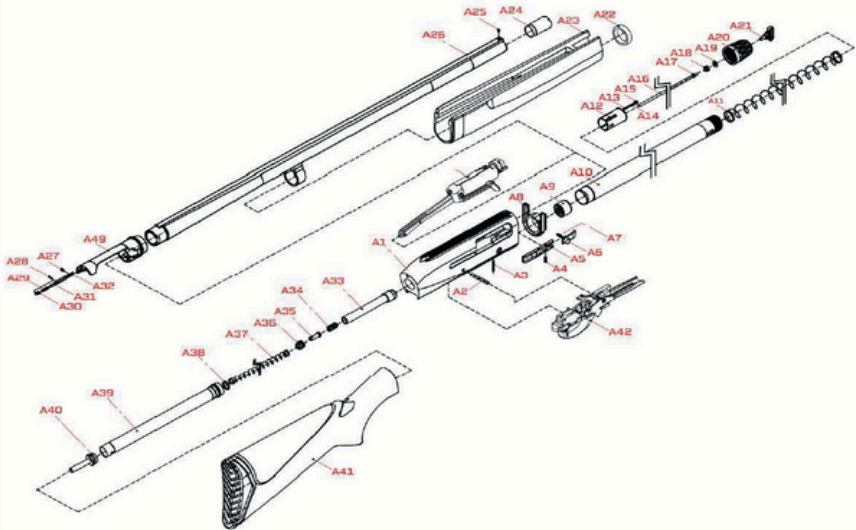

A1 RECEIVER

A2 RECEIVER PIN

A3 LATCH RETAINER PIN

A4 BOLT RELEASE RETAINER PIN

A5 LATCH

A6 BOLT RELEASE

A7 BOLT RELEASE SPRING

A8 FOREND FIXER APARATUS

A9 MAGAZINE FOLLOWER

A10 MAGAZINE TUBE

A11 MAGAZINE SPRING

A12 MAGAZINE BUNG

A13 FOREND NUT SPRING

A14 FOREND NUT PIN

A15 FOREND NUT SCREW

A16 CAPACITY RESTRICTOR

A17 CAPACITY RESTRICTOR SEGMAN

A18 CAPACITY RESTRICTOR NUT

A19 CAPACITY RESTRICTOR WASHER

A20 FOREND NUT

A21 SLING SWIVEL

A22 FOREND FIXER POLYMER*

A23 FOREND

A24 MOBILE CHOKE

A25 FRONT SIGHT

A26 BARREL

A27 SPRING ASSISTED EJECTOR SCREW

A28 SPRING ASSISTED EJECTOR PIN

A29 SPRING ASSISTED EJECTOR SPRING

A30 SPRING ASSISTED EJECTOR BODY

A31 SPRING ASSISTED EJECTOR PIN

A32 SPRING ASSISTED EJECTOR EXTRACTOR

A33 OPERATION FORWARDER

A34 OPERATION FORWARDER SPRING

A35 OPERATION FORWARDER PIN

A36 OPERATION FORWARDER CAP

A37 OPERATION SPRING

A38 OPERATION SPRING SEGMAN

A39 OPERATION BODY

A40 OPERATION BODY NUT

A41 STOCK

A42 FIRE CONTROL GROUP

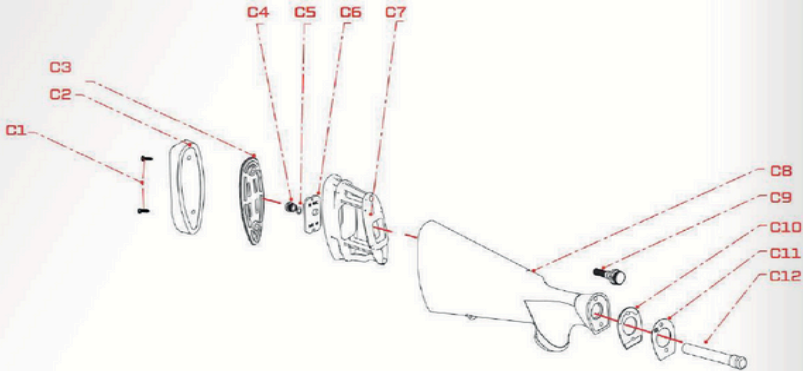

C1 RECOIL PAD SCREW

C2 RECOIL PAD

C3 RECOIL PAD APARATUS

C4 STOCK RETAINING NUT

C5 STOCK RETAINING WASHER

C6 STOCK RETAINING PLATE

C7 STOCK RETAINER BODY

C8 STOCK

C9 RECEIVER CONNECTOR

C10 ADJUSTING PLATE KIT

C11 ADJUSTING PLATE KIT

C12 OPERATION BODY

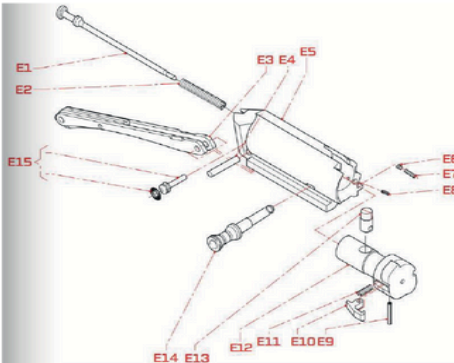

E1 FIRING PIN

E2 FIRING PIN SPRING

E3 BOLT LINK

E4 BOLT LINK PIN

E5 BOLT

E6 CHARGING HANDLE DETENT

E7 CHARGING HANDLE DETENT SPRING

E8 CHARGING HANDLE SPRING RETAINING PIN

E9 EXTRACTOR PIN

E10 EXTRACTOR

E11 EXTRACTOR SPRING

E12 BOLT HEAD

E13 LOCKING HEAD PIN

E14 CHARGING HANDLE

E15 FIRING PIN RETAINING

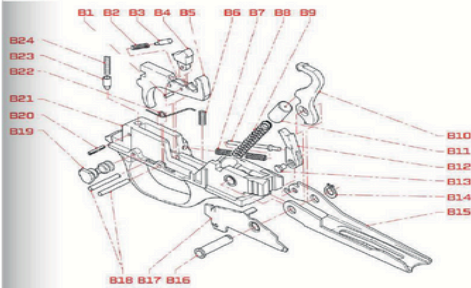

B1 DISCONNECTOR PIN

B2 DISCONNECTOR SPRING

B3 DISCONNECTOR PLUNGER

B4 DISCONNECTOR

B5 TRIGGER

B6 TRIGGER SPRING

B7 CARRIER SPRING

B8 CARRIER SPRING PLUNGER

B9 HAMMER SPRING

B10 HAMMER

B11 HAMMER SPRING CAP

B12 CARRIER DOG

B13 CARRIER DOG PIN

B14 TRIGGER GUARD PIN RING

B15 CARRIER

B16 TRIGGER PIN BUSHING

B17 CARRIER DROP LEVER

B18 TRIGGER PIN

B19 SAFETY BUTTON

B20 SAFETY PLUNGER RETAINER PIN

B21 TRIGGER GUARD

B22 SHELL RELEASE LEVER SPRING

B23 SAFETY PLUNGER

B24 SAFETY PLUNGER SPRING



PAK TURK



BE COURTEOUS

When shooting or hunting always acquire the permission of the landowner. Respect the land. Do not litter, use gates when possible, leave open and closed gates closed. Drive vehicles only where advance permission has been granted and always express gratitude for use of another person's land.

Offer your labour or game as repayment for the privilege of use. Remember you are helping develop a reputation for all sportsmen/sportswomen.

Mail Us

defence@pakturkarms.com

Address

Hamidiye Mahallesi, 40907.Sokak, No:1-A, Beysehir, konya